

The Confetti Family

Just like little pieces of paper floating from the sky can create an amazing image in a parade, Confetti™ offers a fun way to deliver light in small packages. The Confetti™ family's array of options include recessed downlights, wallwashers, eyeball adjustables and surface offerings in the form of tiny monopoints and pendants. Have some fun and throw some Confetti™ to light your space.

PROJECT:

TYPE:

SPECIFIER:

DATE:

Key Points (CF1WW-R)

Trim

- Distinctive, small 1" round semi-recessed wallwasher.
- Flanged trim features micro-bite wing springs.
- Flangeless and Flanged trims available for retrofit type installation, no housing required.
- Unique design of Flangeless Trim allows for truly flat, smooth ceilings when using the Confetti™ Counter Bore Hole Saw. For optimal installation we recommend this tool. Order under accessories.
- White or Black standard finish for aperture bezel and flanged trims.

Housing

- IC Rated / airtight housing approved for use in direct contact with insulation meeting CA Title 24 requirements.
- US - listed for Wet Location
- Wire pigtails are CMP rated for plenum use

Source / Optics

- Wallwash performance lights to top of wall
- 2700K, 3000K and 3500K available.
- 228 delivered lumens from our very small, 1" aperture.
- <3 MacAdam Steps (<3SDCM) for fixed white
- 90 CRI, 60+ R9 Standard
- [View Photometry](#)

Drivers

- Configurable driver box for up to 4 Confetti fixtures on a single remote driver. Can be mixed with other fixtures within the Confetti™ family. Quantity of driver boxes needs to be specified based upon number of fixtures and control zone requirements.
- Remote Universal EldoLED driver, 120-277V
- Flicker free to IEEE 1789-2015 available with EldoLED and TruPhase™ selections
- 0-10, DALI-2, TruPhase™

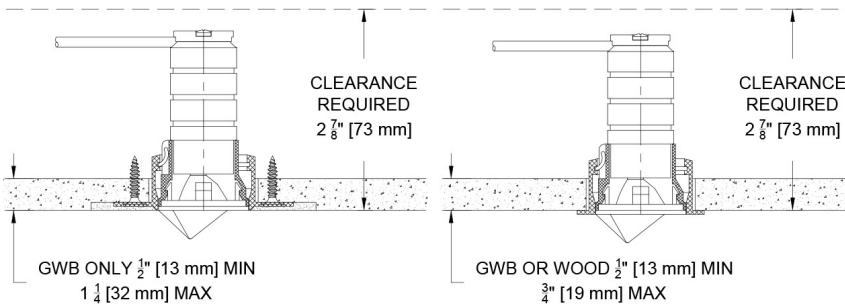
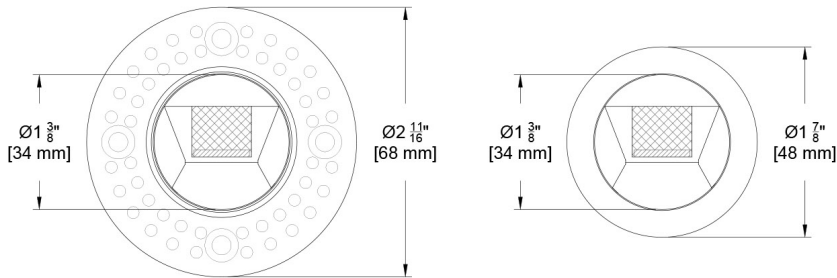
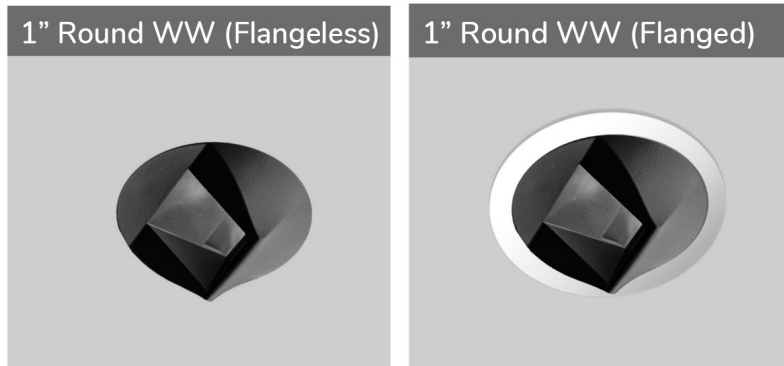

Ordering Codes

PROJECT:

SPECIFIER:

DATE:

TYPE:

QUANTITY:

Ordering Code Example: CF1WW-R-WW-F-SG7-30-WW-CFD/E3-2-B-B

FIXTURE	APERTURE	TRIM	SOURCE / WATTS	CCT	BEAM	DRIVER / CONTROL	DRIVER QUANTITY	BEZEL FINISH	TRIM FINISH	ACCESSORIES
CF1WW-R										
Confetti™ 1" Round Wall Wash	WW Wall Wash	Z Flangeless Trim* F Flanged Trim^	SG7 ●● 7W 228Lm* 90+CRI, 50+R9	27 2700K 30 3000K 35 3500K	WW Wall Wash	CFD/E1 0-10* 0.1%, UNV (120-277V) log CFD/E2 DALI-2* 0.1%, UNV (120-277V) log CFD/E3 0-10* 0.1%, UNV (120-277V) linear K No driver required. (CFD box has been specified with another Confetti product) TR2 TruPhase™ 0.1%, (120-120V) log Up to 20W Forward and Reverse compatible Phase Dimming Static White & Ambient Dim only * Remote driver only. Maximum 4 fixtures per driver.	# Specify number of drivers Must specify # of driver boxes based upon control requirements and 1-4 fixtures per driver. See Electrical Configuration and Control section of cut sheets for details.	B Black Paint W White	B Black Paint W White Paint K Blank for use with Flangeless	CFCBHS Counter Bore Hole Saw for Flangeless Trims Controls ATH Lutron Athena Wireless Node <i>Must be used with E2 driver</i> Recommended for proper installation of Flangeless Trims. Only one required per project.

Ceiling Cutouts and Dimensions

Wall Wash Aperture

Round Flangeless

Wall Wash (WW)

(CF1WW-R-Z-CR7)

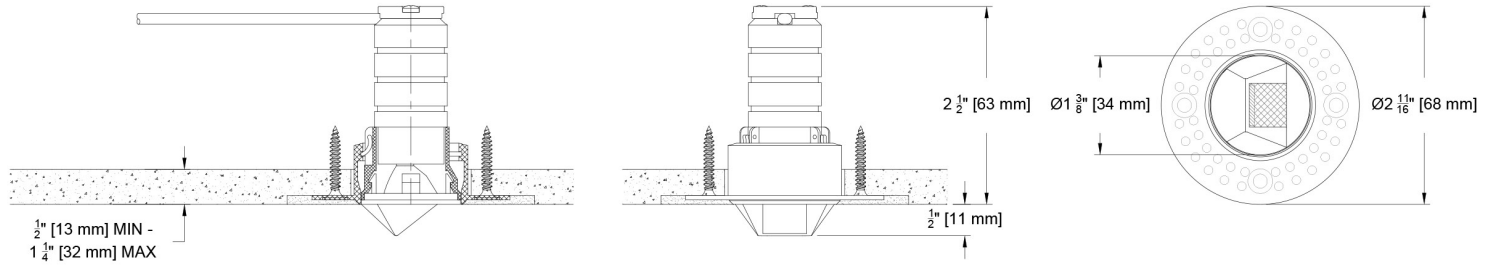

Round Flanged

Wall Wash (WW)

(CF1WW-R-F-CR7)

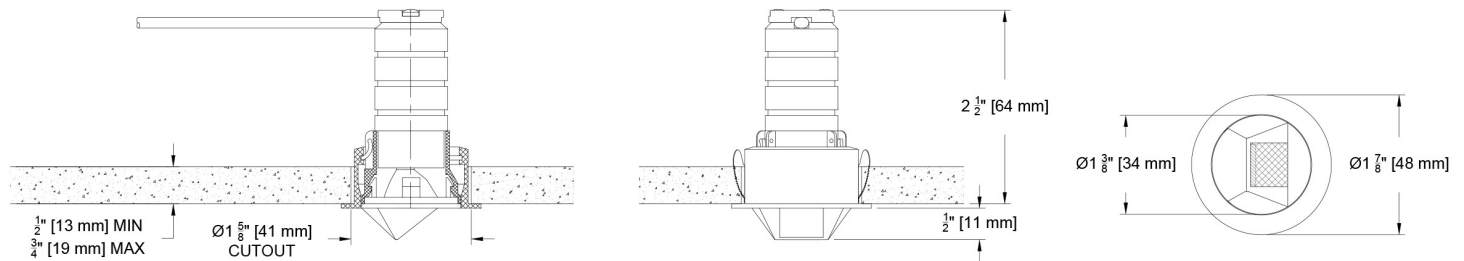

Flangeless Mount Detail

CFCBHS REQUIRED ALONG WITH POWER DRILL FOR THIS CUTOUT. SEE ACCESSORIES

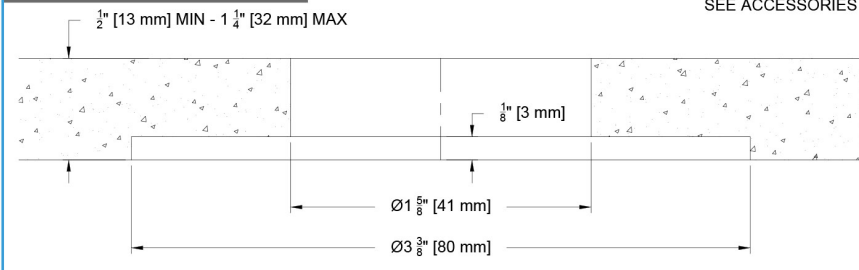

Photometric Table

All data below are delivered lumens based on goniometer measurements of production representative product. All lumen values can vary +/- 10% from LED manufacturer rated nominal flux.

ROUND WW Beamspreads		33°		
Source	System watts (W)	Delivered Lumens (lm)	Lms/Watt	Peak CD
SG7	8	224	29	535
CCT Multiplier				
CCT	SG7			
2700	1.00			
3000	1.00			

All measurements are delivered lumens based on 3000K unless otherwise noted below. Refer to photometry tab on product page for exact ISO cd plot and IES files.

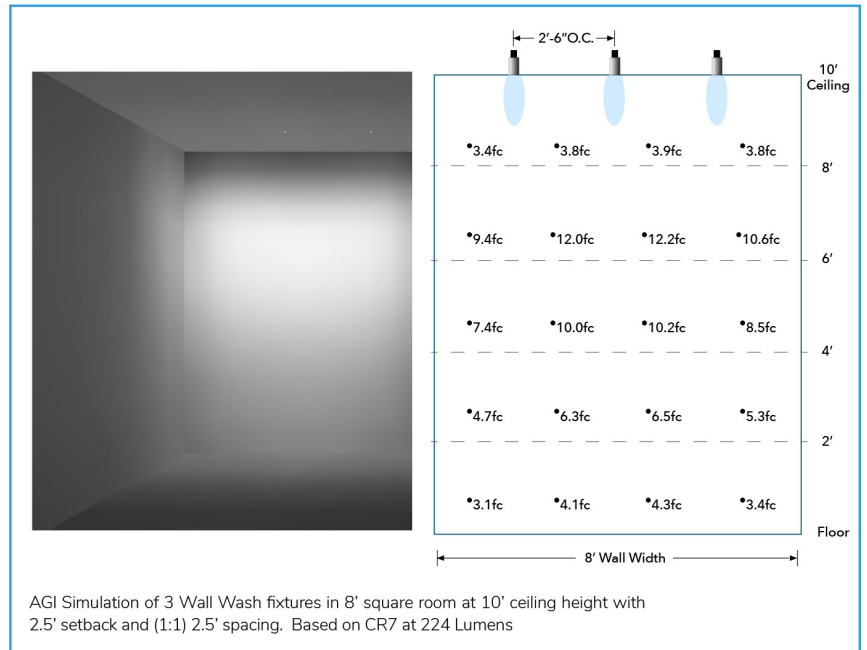

Color Data

All Color information is based on goniometer measurements of production representative product. All values can vary +/- 10% from LED manufacturer data range as listed on their datasheet.

Specialty Array - SG7

- <3 MacAdam Ellipse (<3 SDCM)
- 90+ CRI and RF
- 60+R9, Hue Bin 1 and 16

92 CRI	66 R9
91 RF	98 RG

CRI: 92.8 (R1-R8)

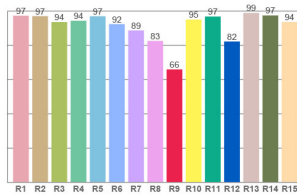

TM30: 91.0

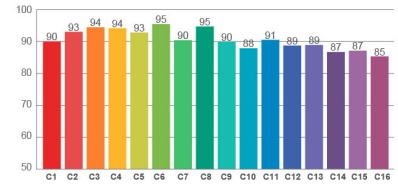

Spectra

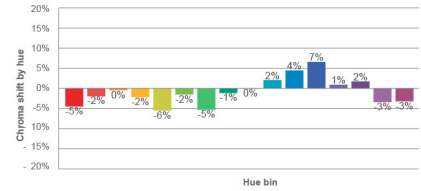
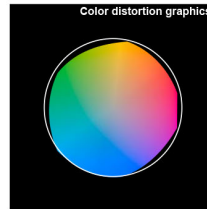
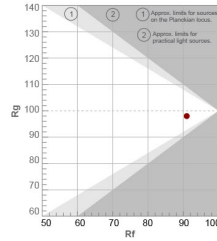
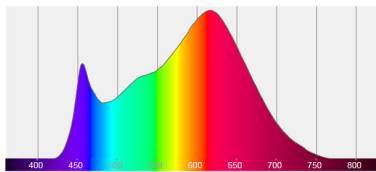

Electrical Configuration and Control

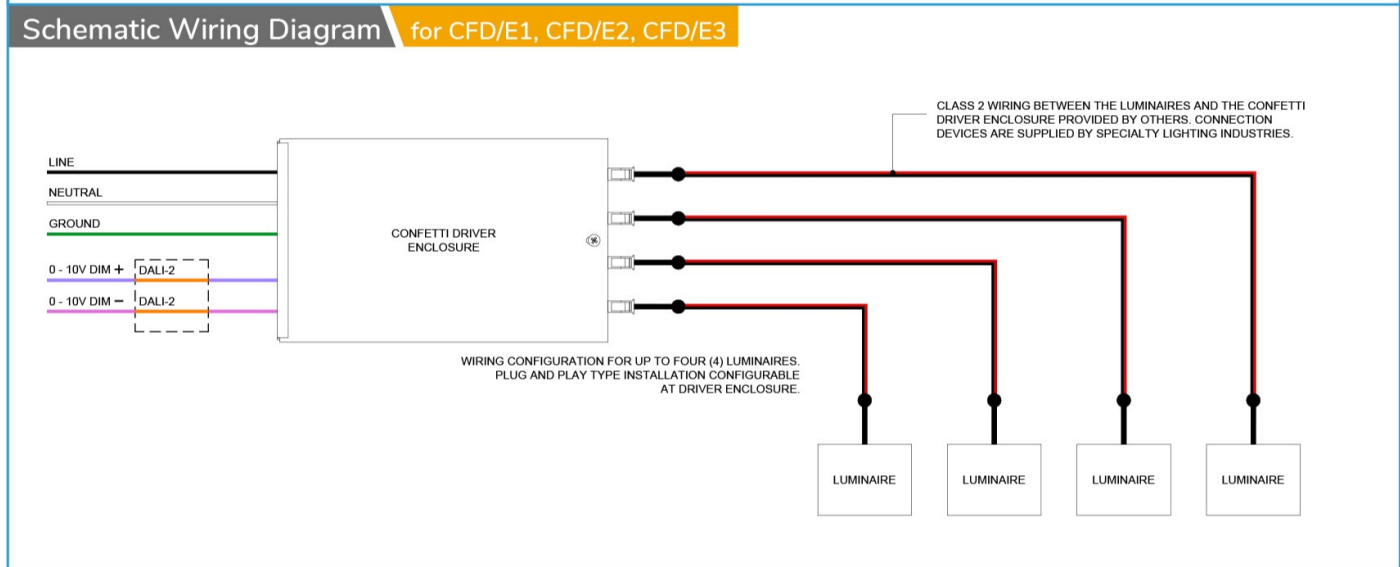
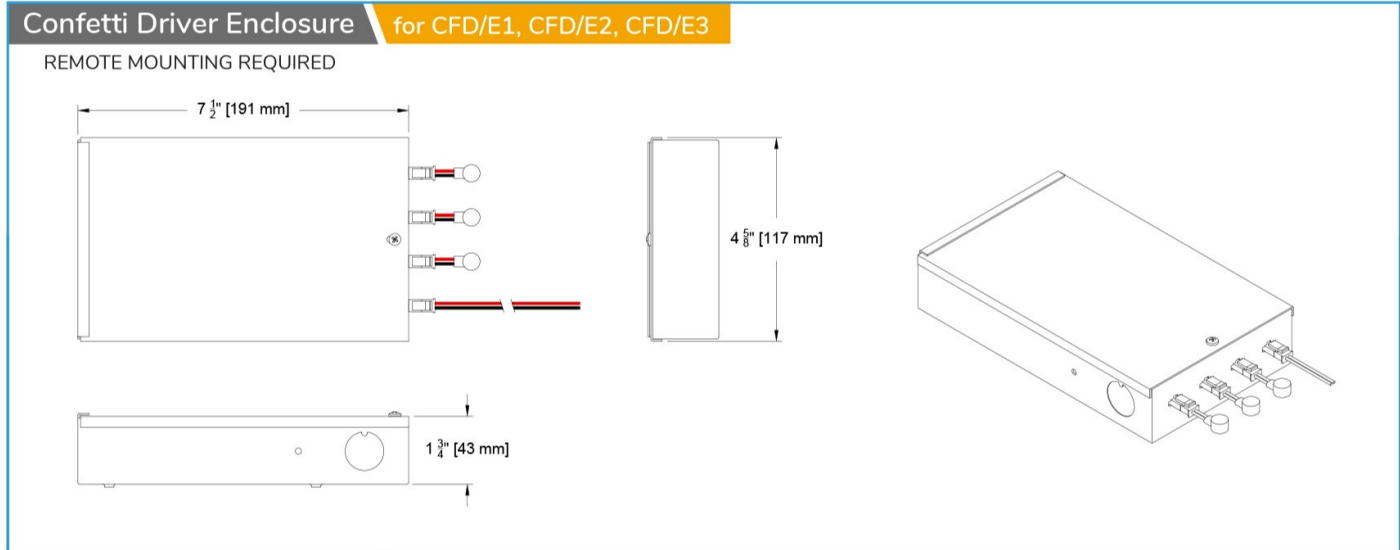

Electrical Configuration and Control

System Wiring Diagram for Confetti Driver Enclosure

for CFD/E1, CDF/E2, CFD/E3

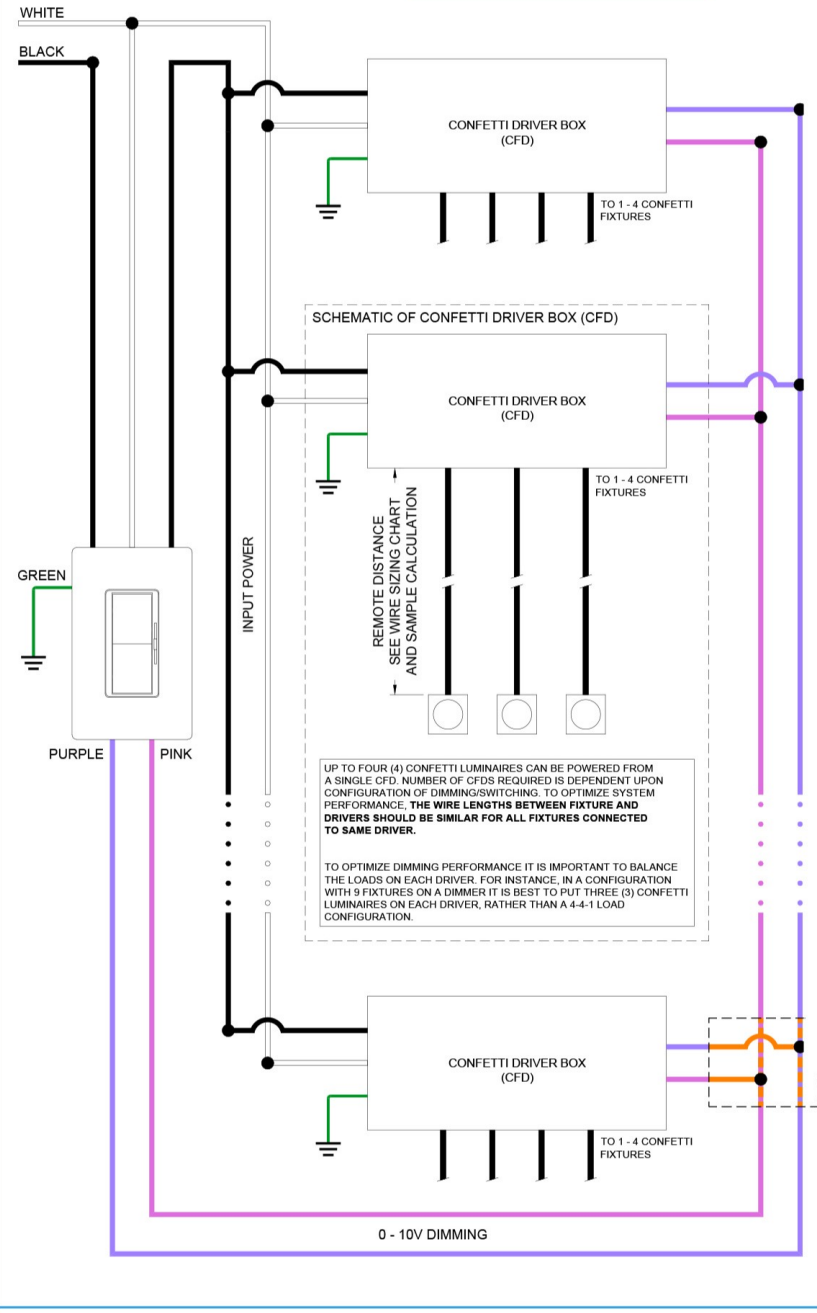

Remote Wire Sizing Chart CFD/E1, CFD/E2, CFD/E3 Drivers

for All Point Sources

Max Remote Distance*	Wire Size
46 ft (14 m)	AWG 20 (0.52 mm ²)
72 ft (22 m)	AWG 18 (0.82 mm ²)
118 ft (36 m)	AWG 16 (1.31 mm ²)

* Max Remote Distance calculated by adding the sum of remote distances for all fixtures connected to driver, i.e. four (4) fixtures connected to a single driver, each 20 feet from driver, the remote distance is 80 feet.

For more information and dimmer compatibility refer to driver manufacturer's website:
EldoLED (E2) Drivers - <https://eldoled.com/product/dualdrive>

EXAMPLE 3 Fixtures @ Various Length each Calculate Max Remote Distance= Add the sum of all fixture lengths

1-4 Confetti Fixtures Max

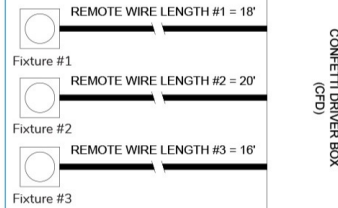

Fixture #1 Remote Wire length= 18'
Fixture #2 Remote Wire Length=20'
Fixture #3 Remote Wire Length=16'
Total Remote Distance = 54'

54' Requires AWG 18 wire because it is less than 72ft maximum distance listed for AWG18.

Note: For the CF1D-RP fixture add 5 feet to remote distance lengths to include the suspension length of the pendant wiring in voltage drop calculations.

Electrical Configuration and Control

System Wiring Diagram for Confetti - TruPhase™ Driver

for TR2

